



## PFM-U400S 系列概述

### 一. 电源规格:

电源型号 (MODEL)	输入 (VAC)	输出 (VDC)	保护功能 (PROTECTION)	尺寸 (SIZE) MM
PFM-U400S5	100~240VAC	5V/70A	SCP/OCP/OVP/OTP	227mm×115mm×50mm
PFM-U400S7	100~240VAC	7V/57A	SCP/OCP/OVP/OTP	227mm×115mm×50mm
PFM-U400S12	100~240VAC	12V/33A	SCP/OCP/OVP/OTP	227mm×115mm×50mm
PFM-U400S24	100~240VAC	24V/17A	SCP/OCP/OVP/OTP	227mm×115mm×50mm
PFM-U400S36	100~240VAC	36V/11A	SCP/OCP/OVP/OTP	227mm×115mm×50mm
PFM-U400S48	100~240VAC	48V/8.5A	SCP/OCP/OVP/OTP	227mm×115mm×50mm

### 二. 系列特性:

#### Features:

- Universal AC input / Full range
- Compact size
- Built in active PFC
- Protections: SCP /OCP/ OVP/ OTP
- Forced air cooling by built-in DC fan
- All using 105°C long life electrolytic capacitors
- High efficiency, High reliability, High working temperature
- 100% full load burn-in test
- 1 years warranty

### 三. 产品外观:



(note: Pictures for reference only, in kind prevail)



## 四. 工作温度，输出功率曲线以及负载曲线图：

Temperature- load curve

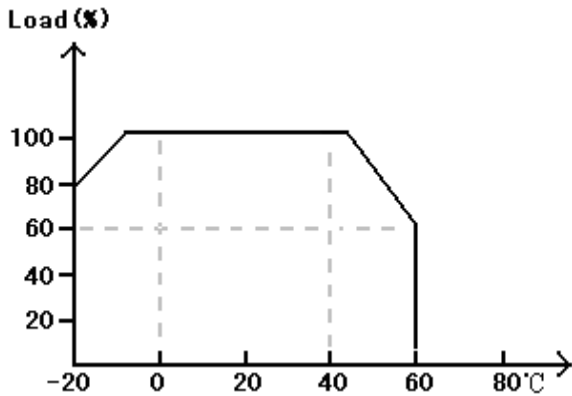

Input voltage- load curve

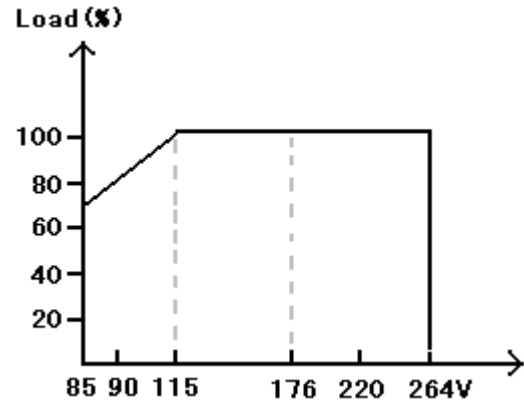

## 五. 测试标准：

## EMC DATA:

## 1、 EMI

RE/CE	EN55022 CLASS A
Harmonics Current	EN61000-3-2

## 2、 EMS

ESD	EN61000-4-2	Air:8KV Contact:4KV	Criteria A
RS	EN61000-4-3	80MHz~1GHz 3V/m	Criteria A
EFT	EN61000-4-4	5KHz AC=1KV	Criteria A
Surge Test	EN61000-4-5	1.2/50us AC:±2KV 8/50us	Criteria A
CS	EN61000-4-6	0.15MHz-80MHz 3V/m	Criteria A
Voltage dips	EN61000-4-8	30% 10ms 60% 100ms >95% 5000ms	Criteria A
Power Frequency Magnetic Field	EN61000-4-11	50Hz 30A/m	Criteria A
RF Electromagnetic Field pulse modulated	ENV50204	900±5MHz 200Hz 3V/m, 50%Duty cycle	Criteria A



六. 安装尺寸:

build in dimension



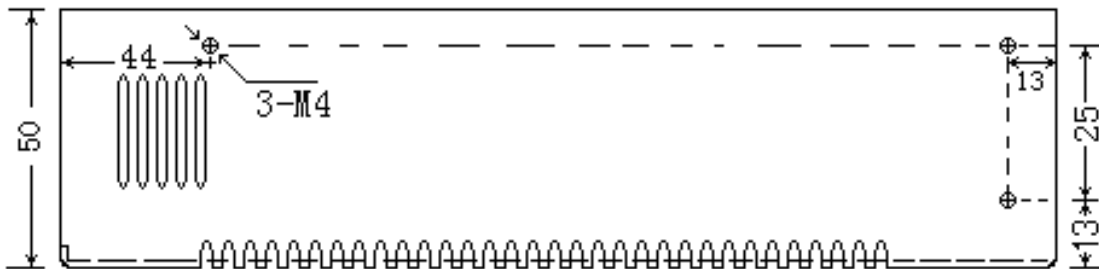
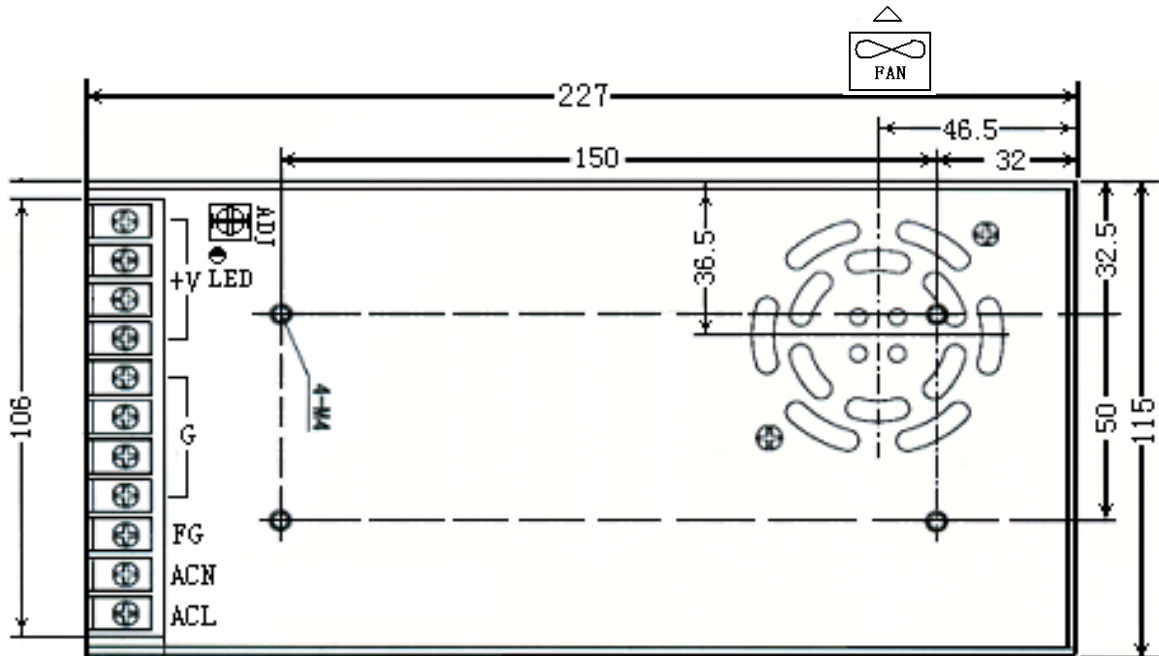
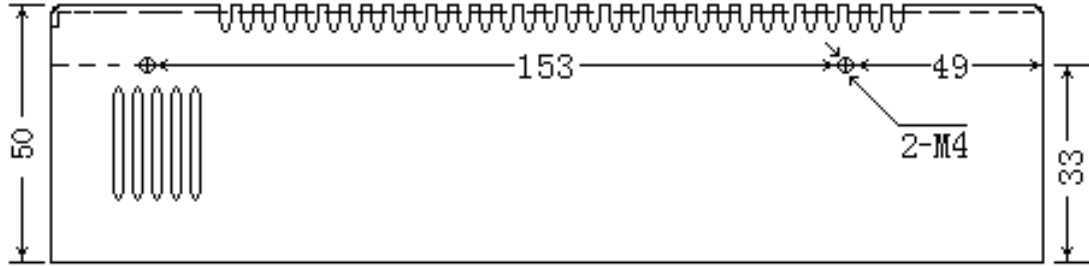

unit: mm





七. 标签:

Connector define

MODEL:	AC INPUT: 100-240VAC I max 5.8A 50/60Hz	 
PFM-U400S48	DC OUTPUT: +48V $\equiv$ 8.5A	
+V	-V	 

ADJ: OUTPUT ADJ



八. 包装:

Packing unit: mm

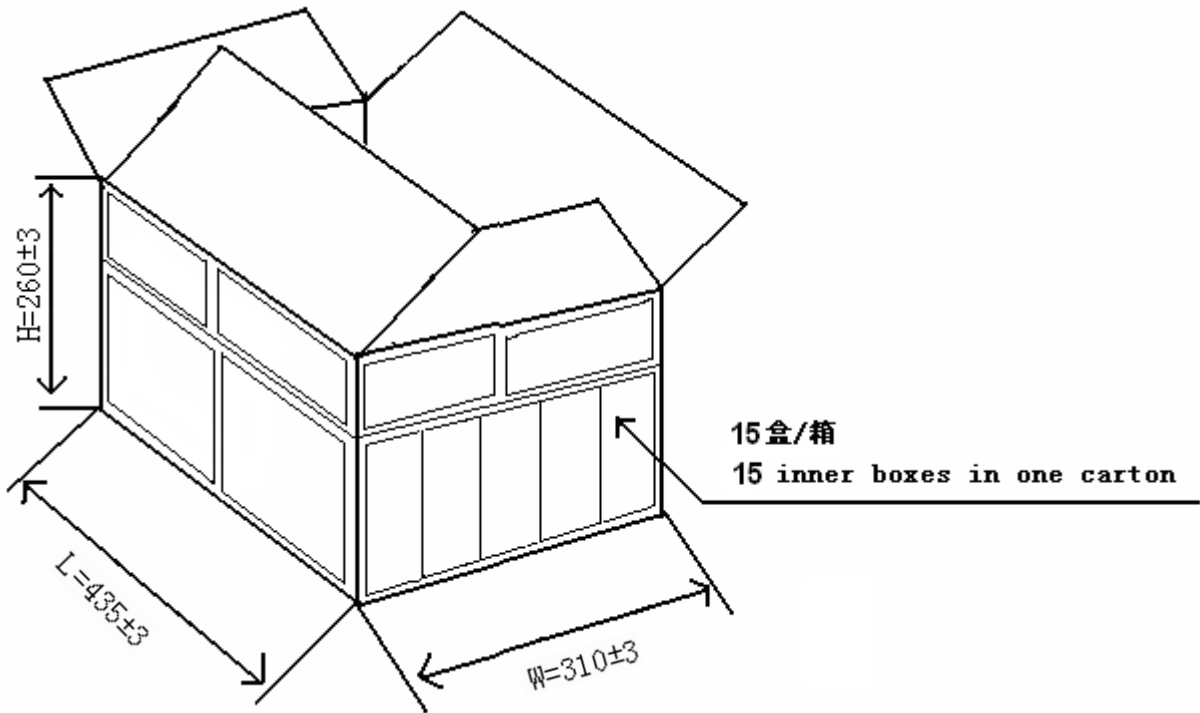

Inner Box plane

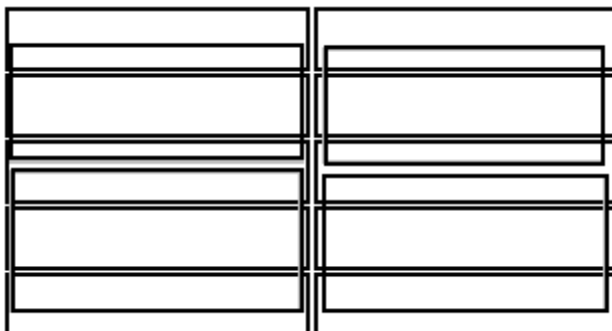

solid

