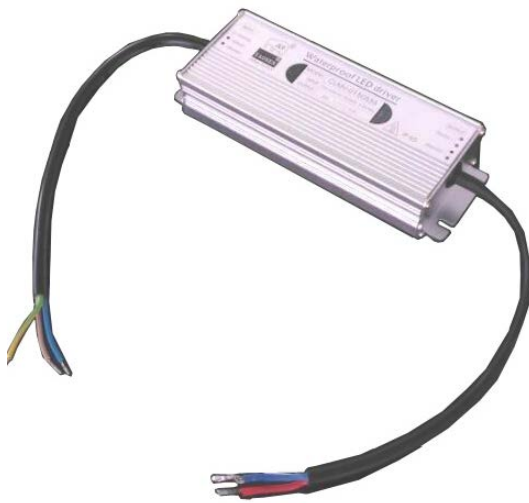

一. 电源规格:

电源型号 (MODEL)	输入 (VAC)	输出 (VDC)	保护功能 (PROTECTION)	尺寸 (SIZE) MM
CLMV-U200S12	100~240VAC	12V/15A	SCP/OCP/OVP/OTP	153mm*62mm*30mm
CLMV-U200S24	100~240VAC	24V/8.3A	SCP/OCP/OVP/OTP	153mm*62mm*30mm
CLMV-U200S27	100~240VAC	27V/7.5A	SCP/OCP/OVP/OTP	153mm*62mm*30mm
CLMV-U200S36	100~240VAC	36V/5.6A	SCP/OCP/OVP/OTP	153mm*62mm*30mm
CLMV-U200S48	100~240VAC	48V/4.2A	SCP/OCP/OVP/OTP	153mm*62mm*30mm

二. 系列特征:
Features

- Universal AC input / Full range
- Slim volume
- Built-in Active PFC PF: >0.99@115VAC; >0.96@230VAC
- Protections: SCP / OCP / OVP / OTP
- Waterproof LED driver, Meet IP 65
- High efficiency, high reliability
- 100% full load burn-in test
- 3 years warranty

三. 产品外观:

Net weight: 635g (灌胶)

INPUT: Φ8 护套线 18# 3 芯棕蓝黄绿 L=300MM

OUTPUT: Φ8 护套线 14# 2 芯红黑 L=300MM

四. 工作温度, 输出功率曲线以及负载曲线图:

Temperature- load curve

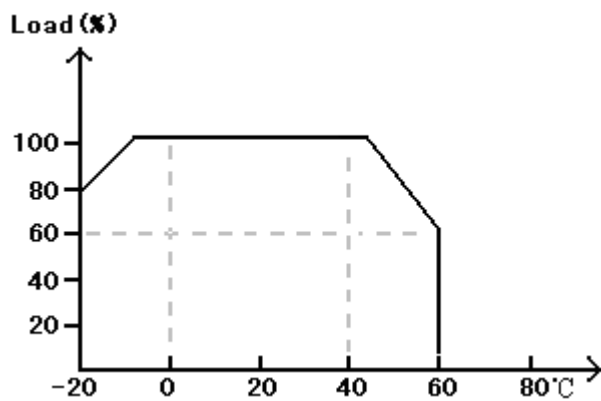

Input voltage- load curve

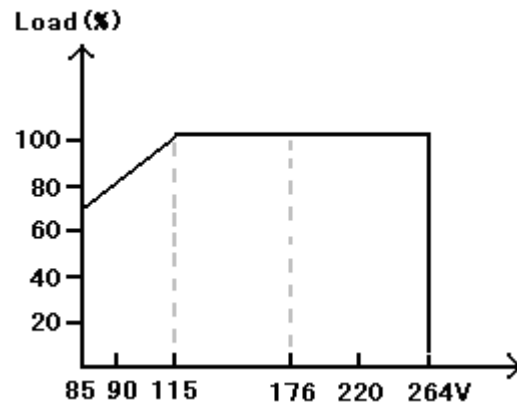

五. 测试标准:

EMC DATA:

1、 EMI

RE/CE	EN55022 CLASS B
Harmonics Current	EN61000-3-2

2、 EMS

ESD	EN61000-4-2	Air:8KV Contact:4KV	Criteria A
RS	EN61000-4-3	80MHz~1GHz 3V/m	Criteria A
EFT	EN61000-4-4	5KHz AC=1KV	Criteria A
Surge Test	EN61000-4-5	1.2/50us AC:±2KV 8/50us	Criteria A
CS	EN61000-4-6	0.15MHz-80MHz 3V/m	Criteria A
Voltage dips	EN61000-4-8	30% 10ms 60% 100ms >95% 5000ms	Criteria A
Power Frequency Magnetic Field	EN61000-4-11	50Hz 30A/m	Criteria A
RF Electromagnetic Field pulse modulated	ENV50204	900±5MHz 200Hz 3V/m, 50%Duty cycle	Criteria A

六. 安装尺寸:

build in dimension

unit: mm

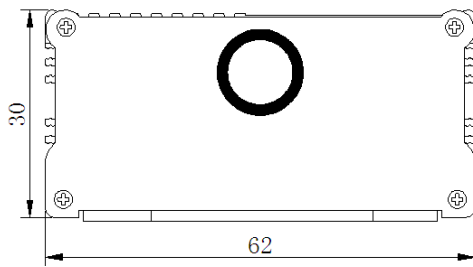
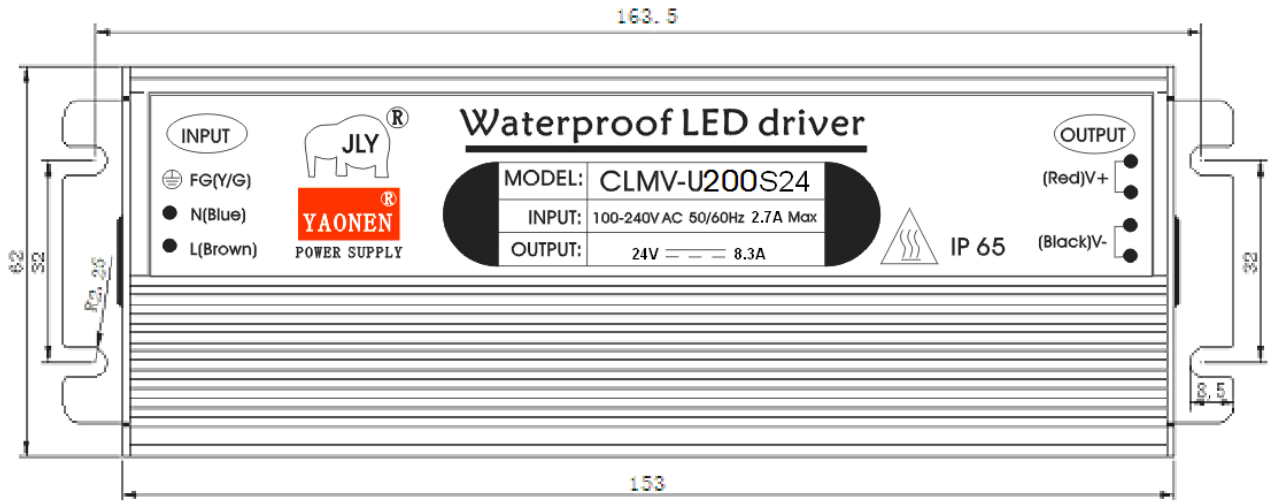

auxiliary cooler

size: 300*300*3.0 (MM)

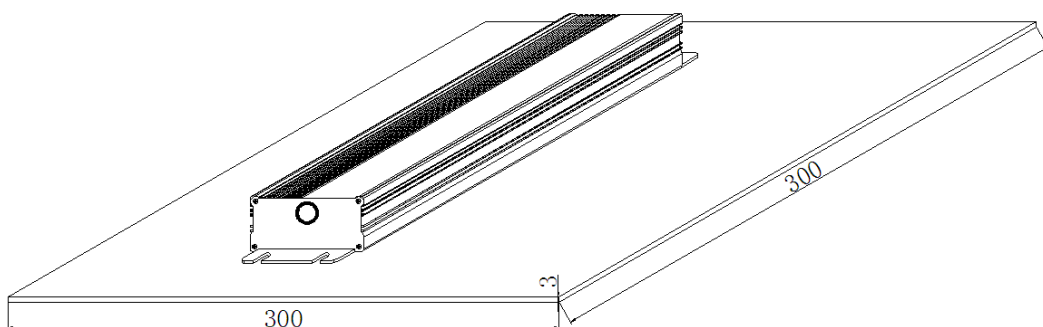
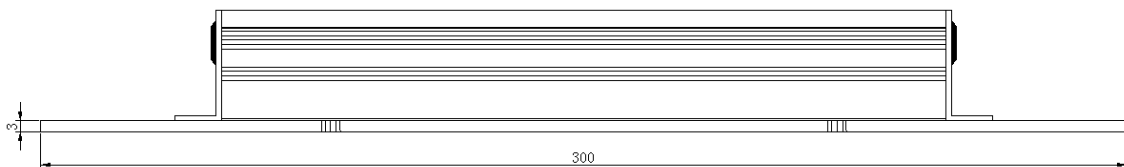

七. 标签:

Spec Label

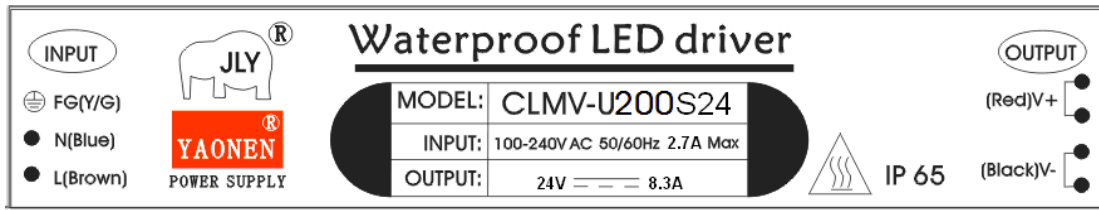

八. 包装:

Packing unit: mm

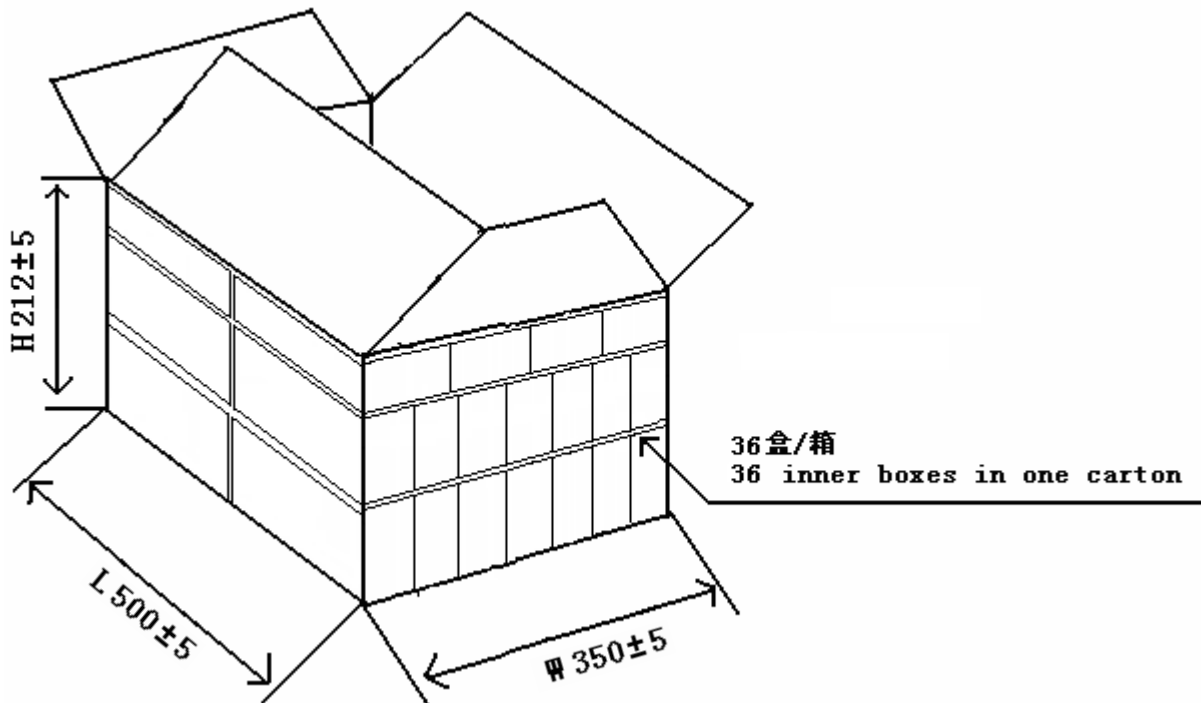

Inner Box plane

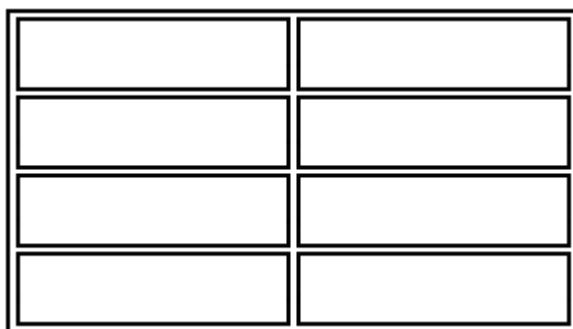

solid

