



LPF-U85S 系列概述

一. 电源规格:

电源型号 (MODEL)	输入 (VAC)	输出 (VDC)	保护功能 (PROTECTION)	尺寸 (SIZE) MM
LPF-U85S12	100~240VAC	12V/7A	SCP/OCP/OVP/OTP	126mm*55mm*35mm
LPF-U85S24	100~240VAC	24V/3.6A	SCP/OCP/OVP/OTP	126mm*55mm*35mm
LPF-U85S28	100~240VAC	28V/3A	SCP/OCP/OVP/OTP	126mm*55mm*35mm
LPF-U85S48	100~240VAC	48V/1.8A	SCP/OCP/OVP/OTP	126mm*55mm*35mm

二. 系列特性:

Features:

- Universal AC input / Full range
- Open frame unit
- Protections: SCP /OCP/ OVP/LVP
- Low cost, High reliability, high efficiency
- 100% full load burn-in test
- 1 years warranty

三. 产品外观:

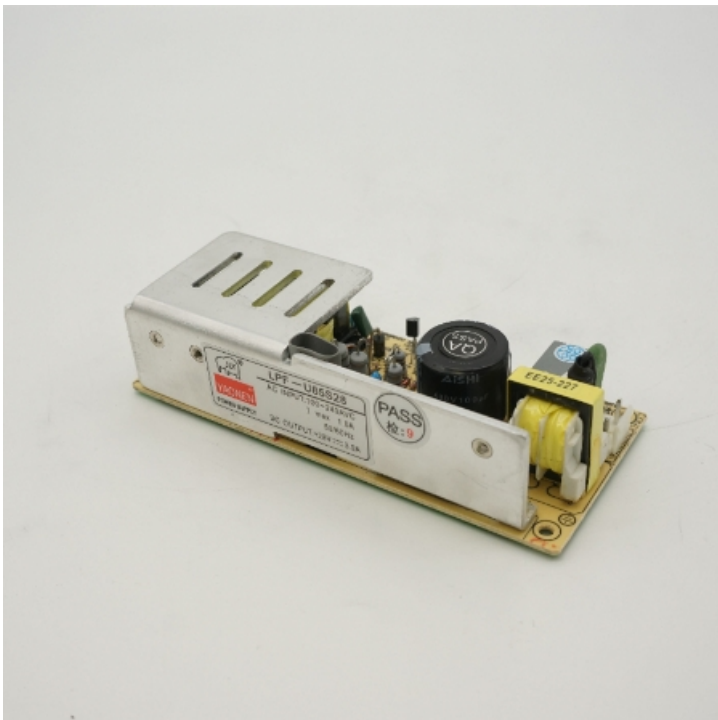

net weight: 210g



四. 工作温度，输出功率曲线以及负载曲线图：

Temperature- load curve

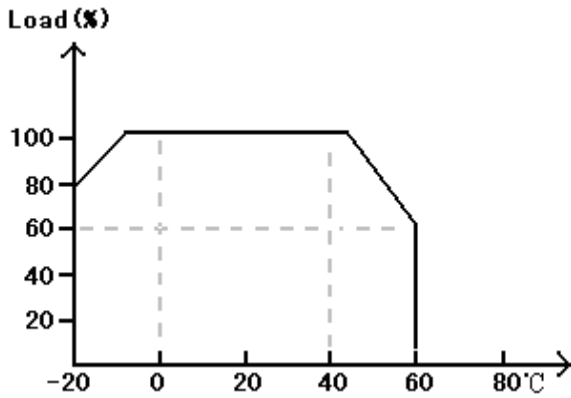

Input voltage- load curve

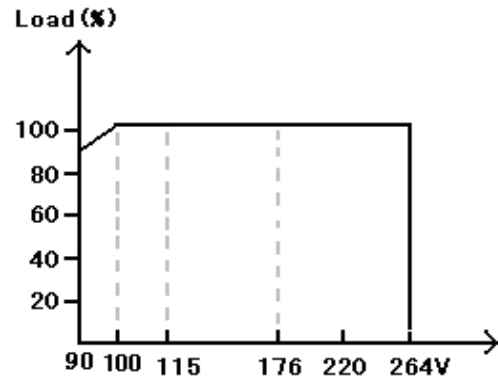

五. 测试标准：

EMC DATA :

1、 EMI

RE/CE	EN55022 CLASS A
Harmonics Current	EN61000-3-2

2、 EMS

ESD	EN61000-4-2	Air:8KV Contact:4KV	Criteria A
RS	EN61000-4-3	80MHz~1GHz 3V/m	Criteria A
EFT	EN61000-4-4	5KHz AC=1KV	Criteria A
Surge Test	EN61000-4-5	1.2/50us AC:±2KV 8/50us	Criteria A
CS	EN61000-4-6	0.15MHz-80MHz 3V/m	Criteria A
Voltage dips	EN61000-4-8	30% 10ms 60% 100ms >95% 5000ms	Criteria A
Power Frequency Magnetic Field	EN61000-4-11	50Hz 30A/m	Criteria A
RF Electromagnetic Field pulse modulated	ENV50204	900±5MHz 200Hz 3V/m, 50%Duty cycle	Criteria A

六. 安装尺寸:

build in dimension

unit: mm

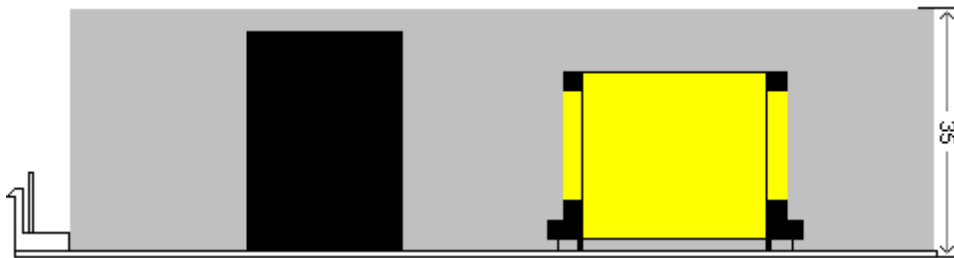
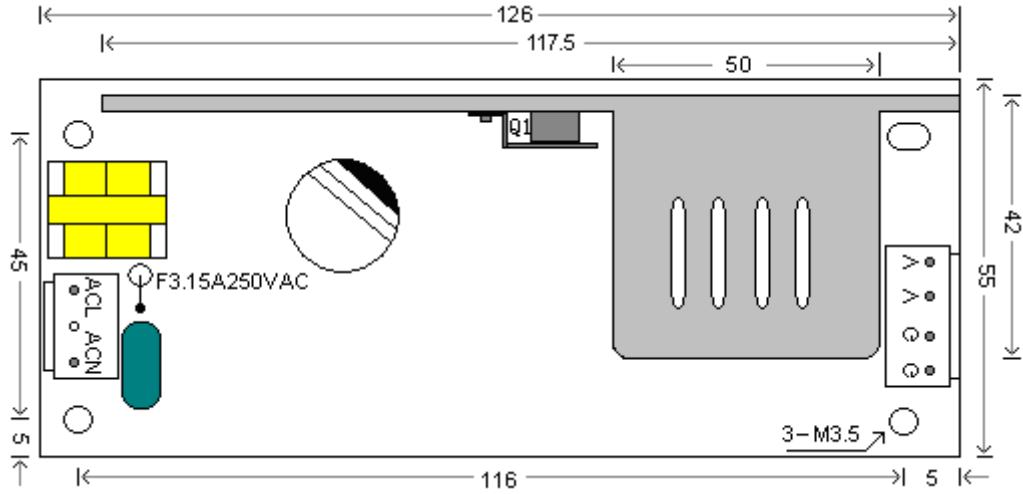



七. 标签:

Spec Label:

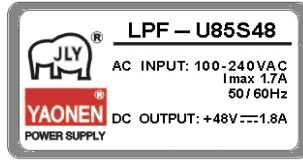

Connector define:

ACN ACL

GND GND +V +V

八. 包装:

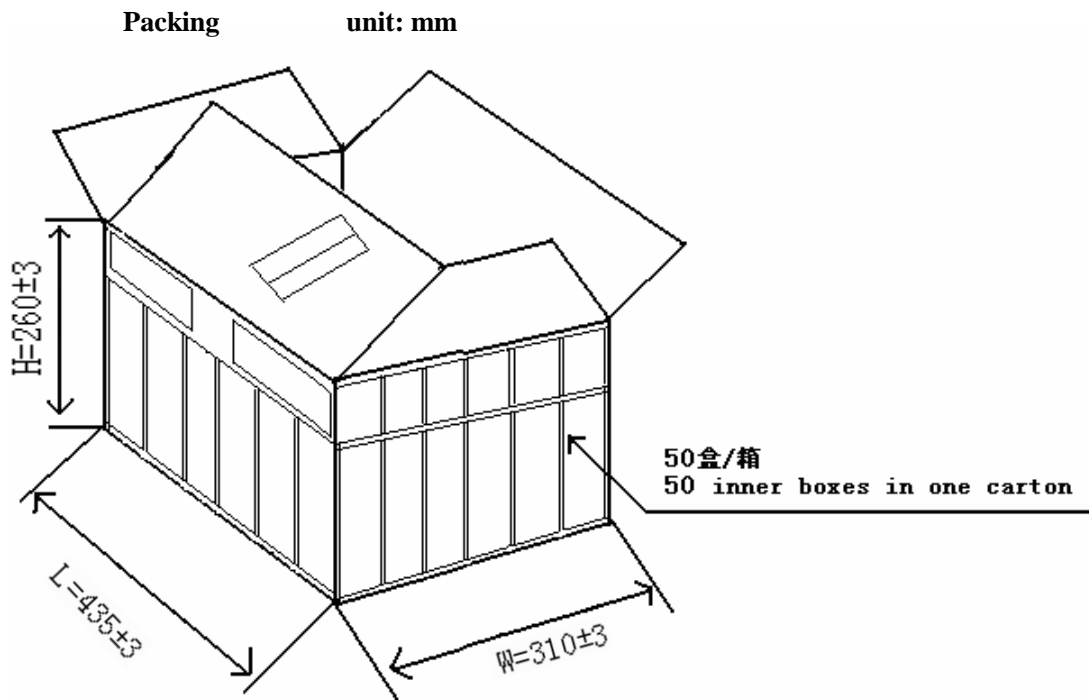

Inner Box plane

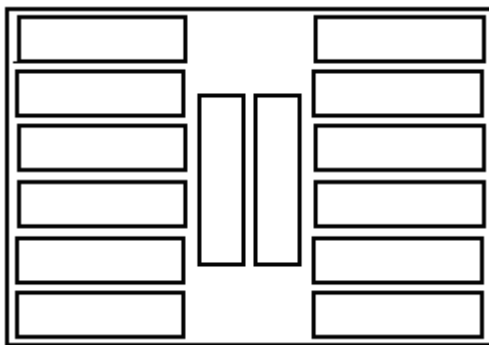

solid

