



PFM-U300S 系列概述

一. 电源规格:

电源型号(MODEL)	输入(VAC)	输出(VDC)	保护功能(PROTECTION)	尺寸(SIZE) MM
PFM-U300S12	100~240VAC	12V/25A	SCP/OCP/OVP/OTP	227mm*115mm*50mm
PFM-U300S24	100~240VAC	24V/12.5A	SCP/OCP/OVP/OTP	227mm*115mm*50mm
PFM-U300S36	100~240VAC	36V/8.3A	SCP/OCP/OVP/OTP	227mm*115mm*50mm
PFM-U300S40	100~240VAC	40V/7.5A	SCP/OCP/OVP/OTP	227mm*115mm*50mm
PFM-U300S48	100~240VAC	48V/6.25A	SCP/OCP/OVP/OTP	227mm*115mm*50mm

二. 系列特性:

Features:

Universal AC input / Full range

Compact size

Built in active PFC

Protections: SCP /OCP/ OVP/ OTP

Forced air cooling by built-in DC fan

All using 105°C long life electrolytic capacitors

High efficiency, High reliability, High working temperature

100% full load burn-in test

2 years warranty

三. 产品外观:



Net weight 1060g

Connection: 11P/9.5mm pitch terminal block

四: 工作温度, 输出功率曲线以及负载曲线图:

Temperature- load curve

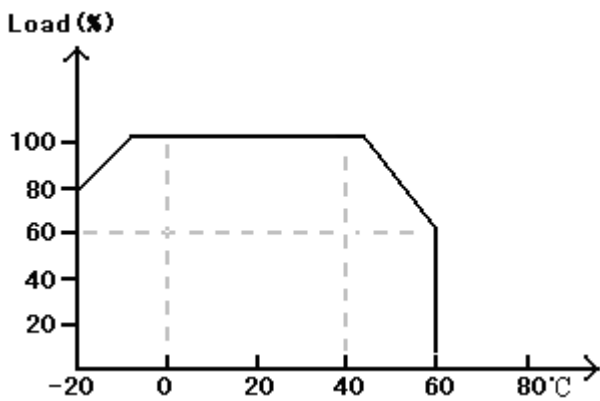

Input voltage- load curve

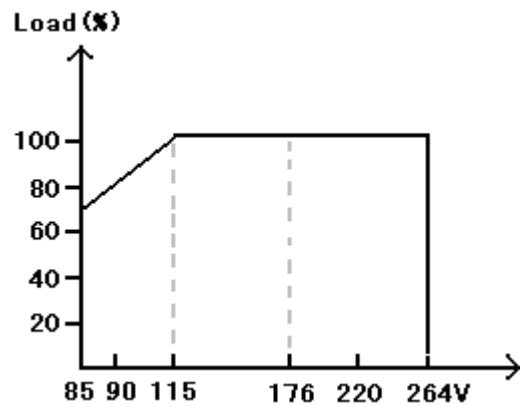

五: 测试标准:

EMC DATA:

1、 EMI

RE/CE	EN55022 CLASS A
Harmonics Current	EN61000-3-2



2、 EMS

ESD	EN61000-4-2	Air:8KV Contact:4KV	Criteria A
RS	EN61000-4-3	80MHz~1GHz 3V/m	Criteria A
EFT	EN61000-4-4	5KHz AC=1KV	Criteria A
Surge Test	EN61000-4-5	1.2/50us AC:+/-2KV 8/50us	Criteria A
CS	EN61000-4-6	0.15MHz-80MHz 3V/m	Criteria A
Voltage dips	EN61000-4-8	30% 10ms 60% 100ms >95% 5000ms	Criteria A
Power Frequency Magnetic Field	EN61000-4-11	50Hz 30A/m	Criteria A
RF Electromagnetic Field pulse modulated	ENV50204	900+/-5MHz 200Hz 3V/m, 50%Duty cycle	Criteria A

六： 安装尺寸：

build in dimension

unit: mm

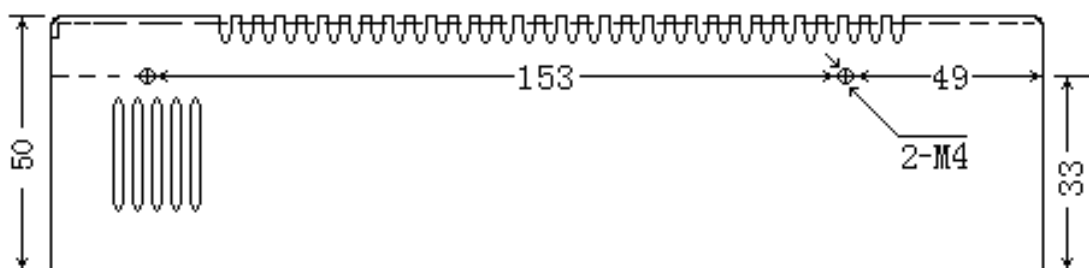

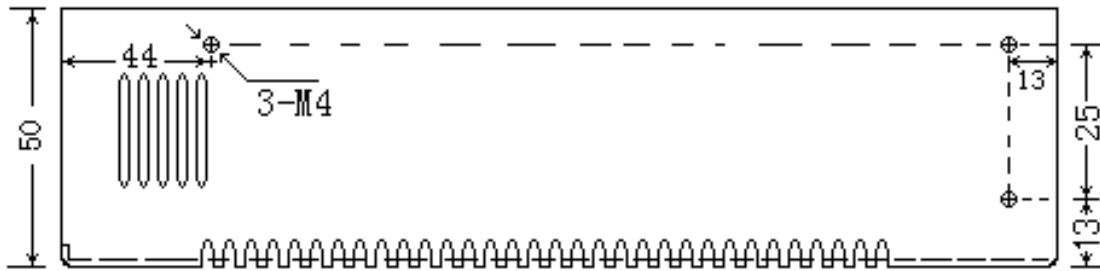
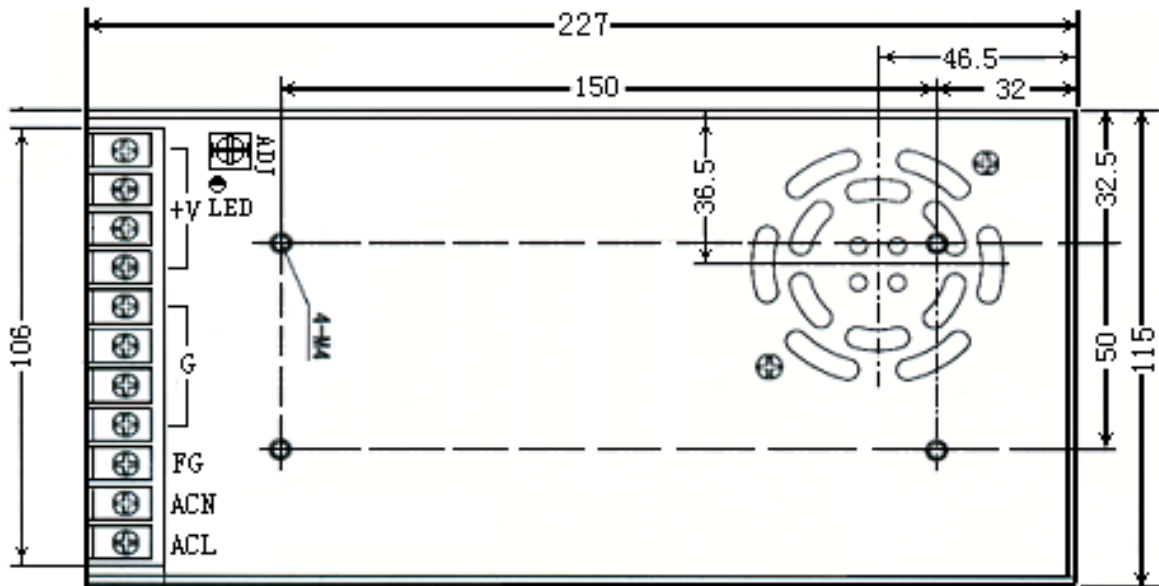

七标签:

Spec Label

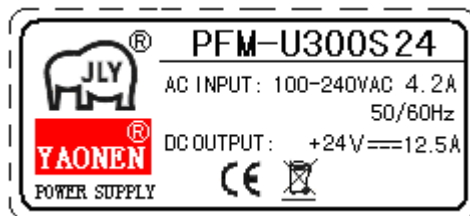

Connector define

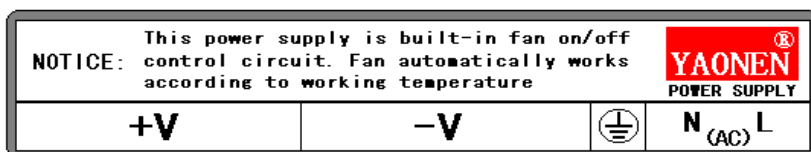

ADJ:OUTPUT ADJ





八：包装：

Packing unit: mm

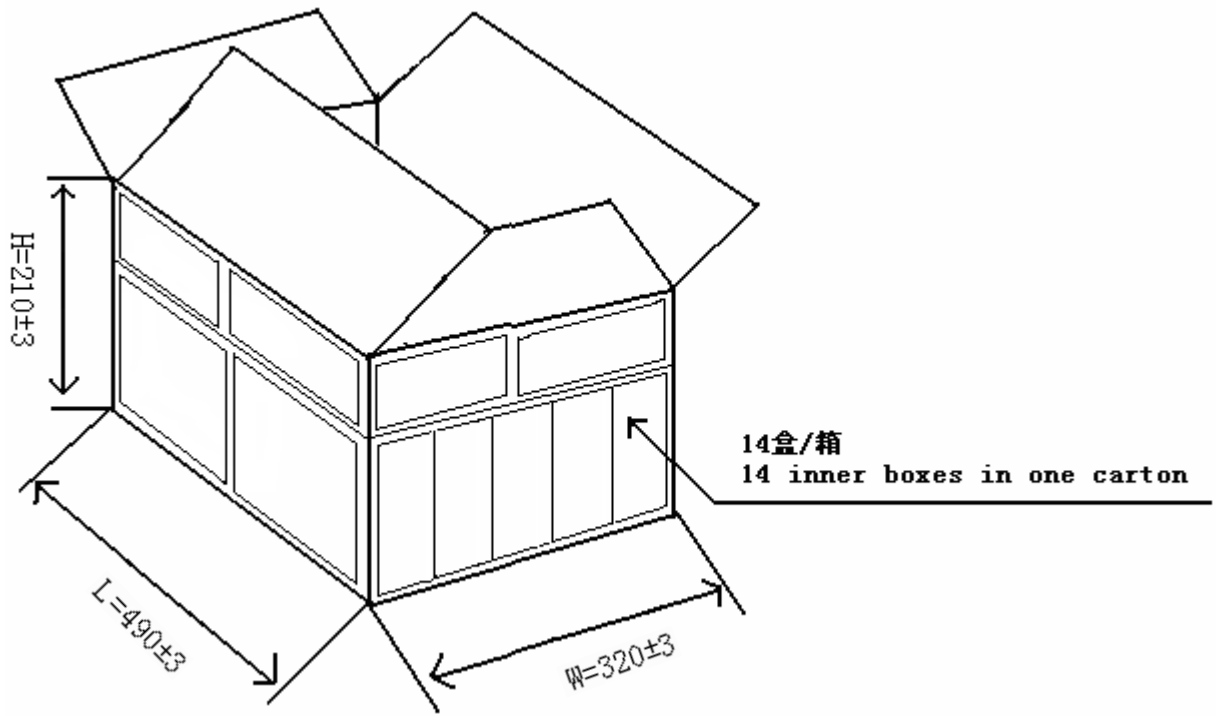

Inner Box plane

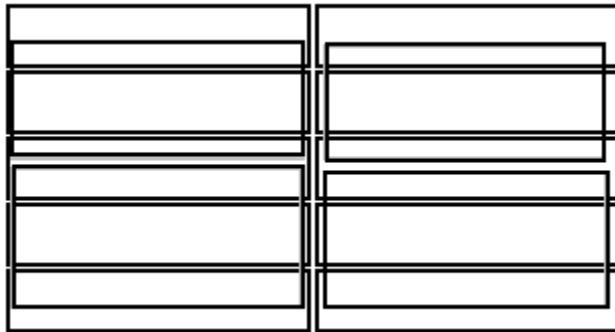

solid

