



GB-ADP-U20S 系列概述

一. 电源规格:

电源型号 (MODEL)	输入 (VAC)	输出 (VDC)	保护功能 (PROTECTION)	尺寸 (SIZE) MM
GB-ADP-U20S5	100~240VAC	5V/3A	SCP/OCP/OVP	76MM*50MM*56MM
GB-ADP-U20S12 (3C)	100~240VAC	12V/2A	SCP/OCP/OVP	76MM*50MM*56MM
GB-ADP-U20S24	100~240VAC	24V/1A	SCP/OCP/OVP	76MM*50MM*56MM

二. 系列特征:

AC input 100-240VAC

Miniature

Protections: SCP /OCP/ OVP

High efficiency, high reliability

100% full load burn-in test

3 years warranty

三. 产品外观



Net weight (重量): 110g

Connector: Input:LCF-216H 中规

Output:22#-A Φ2.1 弹-20A-150cm 方卡 7X5

四. 工作温度、输出功率曲线以及负载曲线图:

Temperature- load curve

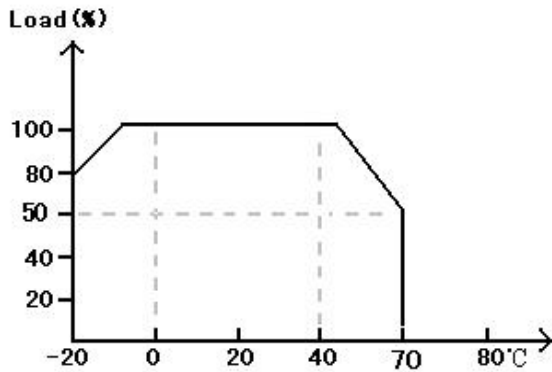

Input voltage- load curve

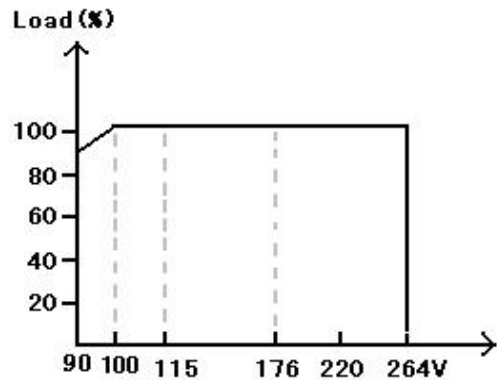

五. 测试标准:

EMC DATA:

1、 EMI

RE/CE	EN55022 CLASS A
Harmonics Current	EN61000-3-2

2、 EMS

ESD	EN61000-4-2	Air:8KV Contact:4KV	Criteria A
RS	EN61000-4-3	80MHz~1GHz 3V/m	Criteria A
EFT	EN61000-4-4	5KHz AC=1KV	Criteria A
Surge Test	EN61000-4-5	1.2/50us AC: ±2KV 8/50us	Criteria A
CS	EN61000-4-6	0.15MHz-80MHz 3V/m	Criteria A
Voltage dips	EN61000-4-8	30% 10ms 60% 100ms >95% 5000ms	Criteria A
Power Frequency Magnetic Field	EN61000-4-11	50Hz 30A/m	Criteria A
RF Electromagnetic Field pulse modulated	ENV50204	900±5MHz 200Hz 3V/m, 50%Duty cycle	Criteria A

六. 安装尺寸

build in dimension

unit: mm

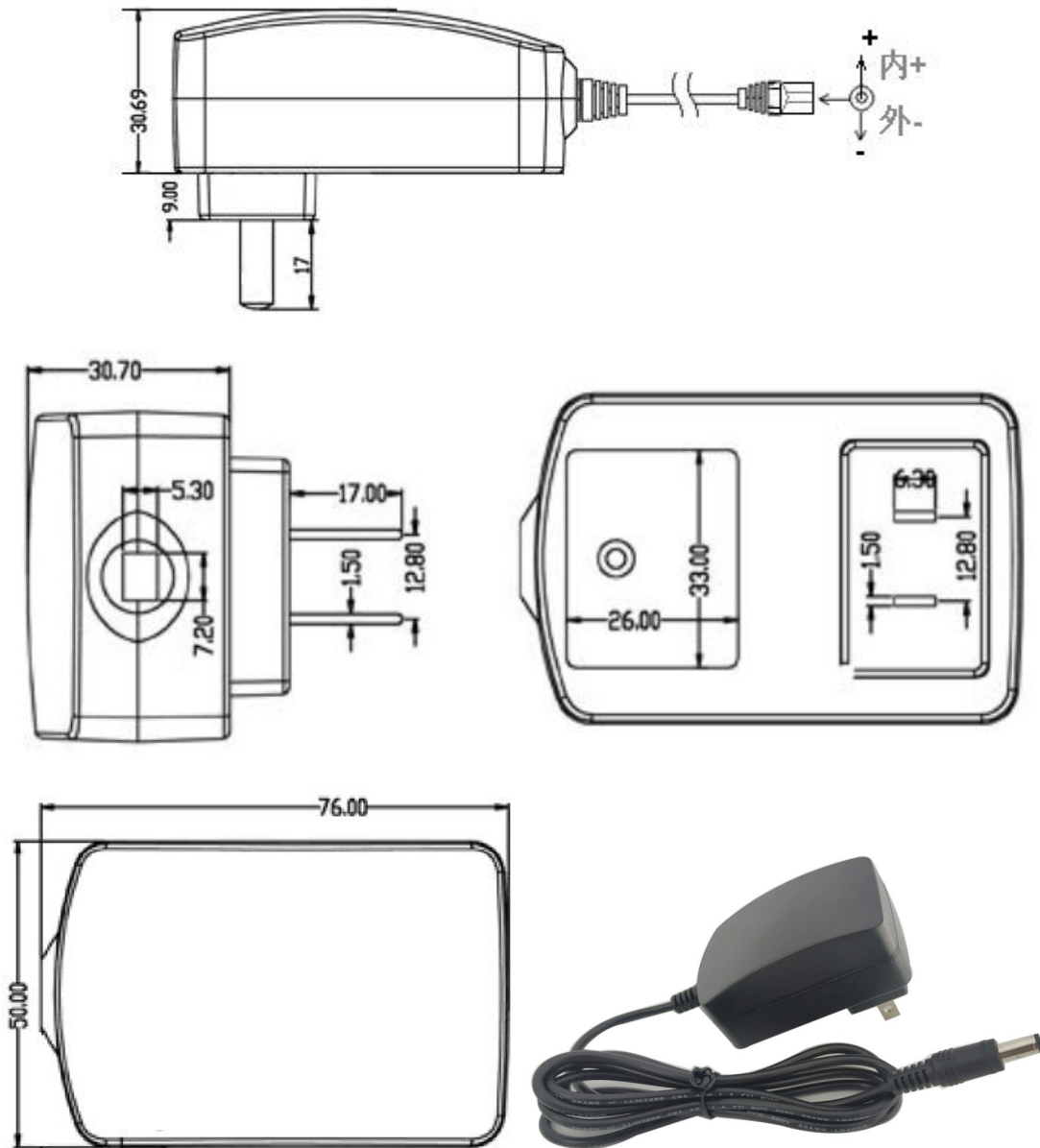

Connection

OUTPUT: $\Phi 2.1$ plugs

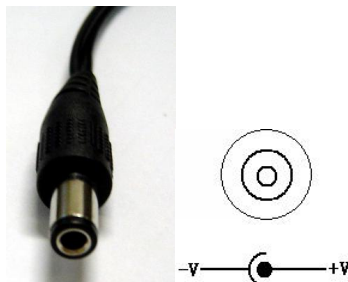

七. 标签:

MODEL: GB-ADP-U20S5

Spec Label



八. 包装:

Packing

unit: mm

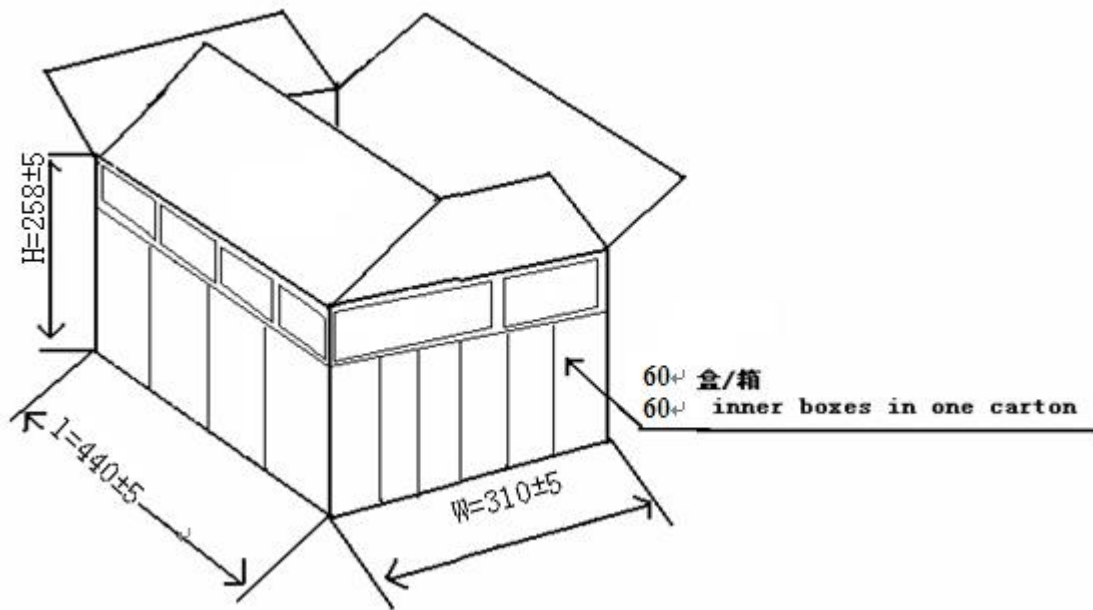

Inner Box plane

solid

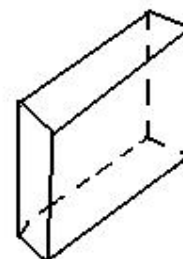
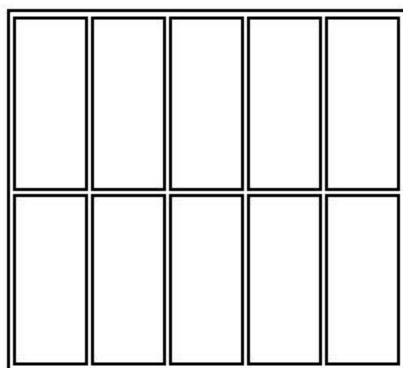

11.1*7*7MM